

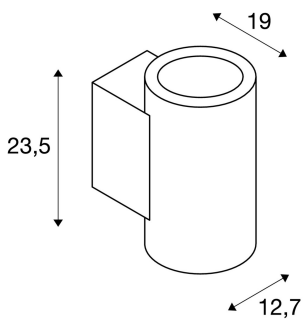

SUPROS

wall light, LED, 4000K, round, black, 60° reflector, 2x15,2W

The SUPROS light series impresses with its multitude of possible applications, excellent LED technology and its harmonious design. With its very high luminous flux, the SUPROS product family is ideally suited to replace power-hungry, conventional lighting installations. The wide-area reflector included in the delivers can be replaced by reflectors with narrower beam angles which are optionally available. This can be done without the need for tools. With the factory-installed LED driver, all the luminaires in the series are suitable for direct connection to the 230V mains supply.



TECHNICAL DATA

Item no.:	114190
Number of different light outlets	2
Primary nominal voltage	220-240V ~50/60Hz mA/V
Secondary power / secondary voltage	1000 mA/V
Width	12.7 cm
Height	23.5 cm
Depth	19.0 cm
Net weight	1.994 kg
Gross weight	2.123 kg
IP Code	IP 20
Safety class	I
Assembly	Surface
Assembly details	Wall
Wattage	34.0 W
Lumen	3100 lm
Colour temperature	4000 Kelvin
Beam angle	60 °
Color	black
CRI	>80
Binning	3
LXXBXX data	70/50
Service life	50000 h

Accessories

114102	REFLECTOR , for SUPROS, 20°, incl. glass and fixing ring
114104	REFLECTOR , for SUPROS, 40°, incl. glass and fixing ring

Notes
