

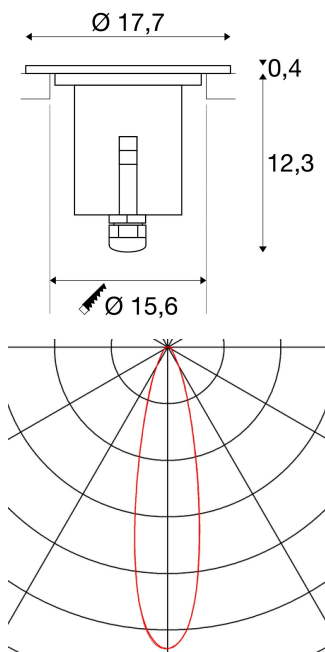

DASAR 180 PREMIUM

outdoor inground fitting, LED, 3000K, IP67, round, bezel stainless steel, 24°, Ø/H 17.7/12.71 cm, 24W

The walk-on and scratch resistant high-voltage inground fitting DASAR 180 PREMIUM with its round stainless-steel bezel and glass cover is fitted with warm-white, high-performance power LEDs. With its IP67 protection class, the luminaire is suitable for outdoor use. The electrical connection is made directly to the 230V mains supply. In addition, the luminaire has high thermal, chemical, mechanical and optical resistance. There are other versions of the luminaire with different beam angles or, alternatively, with a stainless steel housing available. This luminaire contains built-in LED lamps.



TECHNICAL DATA

Item no.:	233752
Lamps included	0
Primary nominal voltage	220-240V ~50/60Hz mA/V
Secondary power / secondary voltage	750 mA/V
Diameter	17.7 cm
Depth	12.7 cm
Installation diameter	15.6 cm
Installation depth	16.4 cm
Net weight	2.65 kg
Gross weight	3.18 kg
IP Code	IP 67
Safety class	I
Impact resistance class	IK08
Impact resistance	5 Joule
Assembly	Recessed
Assembly details	Ground
Wattage	32.0 W
Lumen	3000 lm
Colour temperature	3000 Kelvin
Beam angle	24 °
Color	stainless steel
CRI	>80

Accessories

1000655	Inground mounting pot , black for DASAR® PREMIUM and GIMBLE OUT
228726	T-CONNECTIONBOX , black, IP68

Binning	6
LXXBXX data	70/50
Service life	30000 h
Maximum ambient temperature	40 °C
Mechanical loading	2 t

Notes
